



HYTORC Washer

The HYTORC Washer is the simplest upgrade for instant improvements in safety, speed and accuracy. This unique, patented system eliminates the need for reaction arms and other custom fixtures required to hold the tool in place. Additionally, the precision machined surface reduces variation in bolt load across the flange for improved accuracy and loosening prevention.

Safety



The HYTORC Washer eliminates the need for reaction arms, which are the most common cause of injury on bolting jobs. The unique design of the washer allows the double layered safety socket to react on the washer itself, while turning the nut.

Speed



The HYTORC Washer removes the complicated setup associated with other bolting systems and makes the bolting process more intuitive for improved job times.

System Comparison

STANDARD REACTION FIXTURE

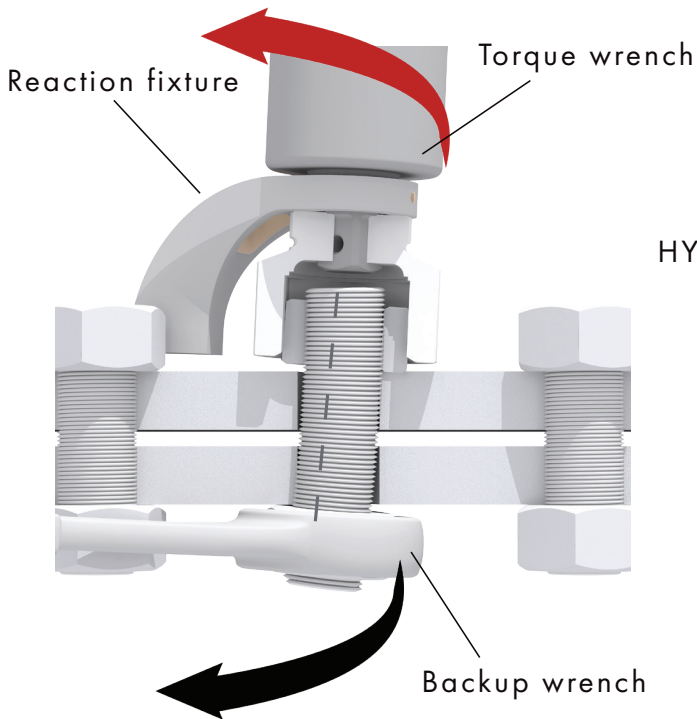

HYTORC WASHER

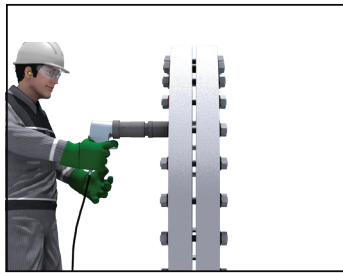
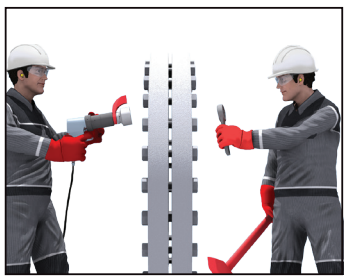
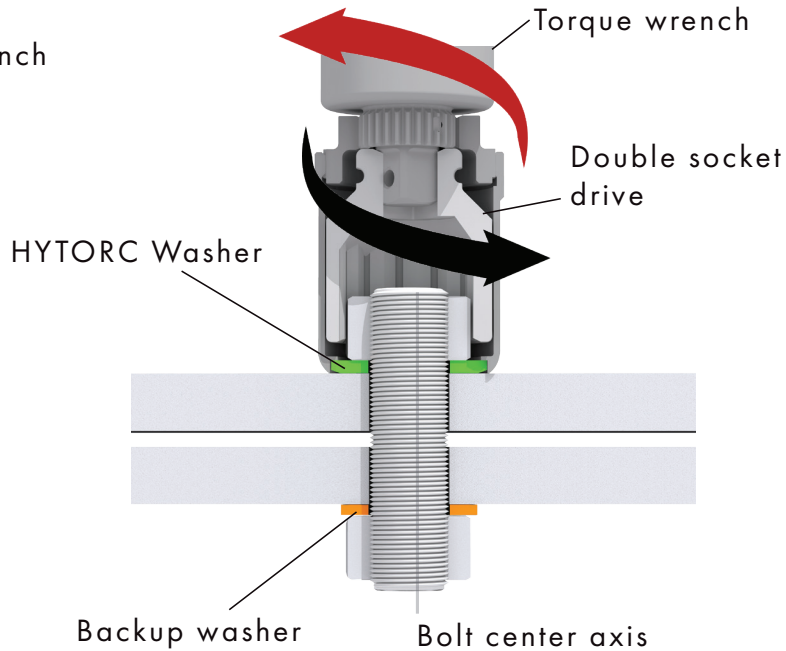

SAFE

No pinch hazard.
Intuitive operation.
Less personnel.

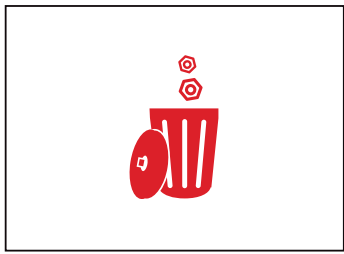

ECONOMICAL

By eliminating damaging side loads and bending forces, nuts and bolts can be reused more often and tool and flange longevity is increased.

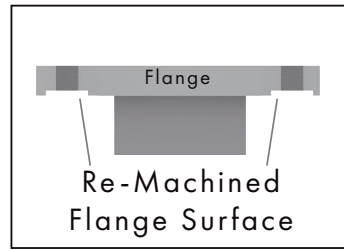
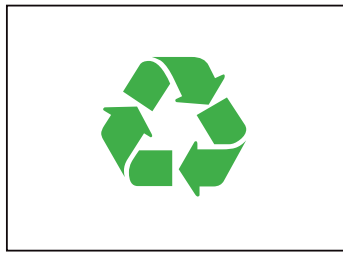

PROTECTIVE

The HYTORC Washer protects the flange surface, eliminating the need for expensive flange resurfacing processes.

